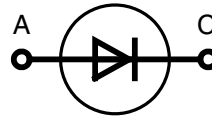

Avalanche Diode

$V_{RRM} = 1200-1800 \text{ V}$
 $I_{F(RMS)} = 18 \text{ A}$
 $I_{FAVM} = 11 \text{ A}$

V_{RSM}	$V_{(BR)min}$	V_{RRM}	Type
V	V	V	
1300	1300	1200	DSA 9-12F
1700	1750	1600	DSA 9-16F
1900	1950	1800	DSA 9-18F

DO-203 AA

A = Anode, C = Cathode

Symbol	Conditions	Maximum Ratings	
I_{FRMS}	$T_{VJ} = T_{VJM}$	18	A
I_{FAVM}	$T_C = 150^\circ\text{C}; 180^\circ \text{ sine}$	11	A
P_{RSM}	$T_{VJM}, t_p = 10 \text{ ms}$	4.5	kW
I_{FSM}	$T_{VJ} = 45^\circ\text{C};$ t = 10 ms (50 Hz), sine t = 8.3 ms (60 Hz), sine	250	A
		265	
I^2t	$T_{VJ} = 150^\circ\text{C};$ t = 10 ms (50 Hz), sine t = 8.3 ms (60 Hz), sine	200	A
		220	
I^2t	$T_{VJ} = 45^\circ\text{C};$ t = 10 ms (50 Hz), sine t = 8.3 ms (60 Hz), sine	310	A ² s
		295	
I^2t	$T_{VJ} = 150^\circ\text{C};$ t = 10 ms (50 Hz), sine t = 8.3 ms (60 Hz), sine	200	A ² s
		190	
T_{VJ}		-40...+180	°C
T_{VJM}		180	°C
T_{stg}		-40...+180	°C
M_d	mounting torque	2.2...2.8	Nm
Weight	typical	5	g

Features

- International standard package JEDEC DO-203 AA
- Planar passivated chips

Applications

- Supplies for DC power equipment
- DC supply for PWM inverter
- Field supply for DC motors
- Battery DC power supplies

Advantages

- Space and weight savings
- Simple mounting
- Improved temperature & power cycling
- Reduced protection circuits

Dimensions in mm (1 mm = 0.0394")

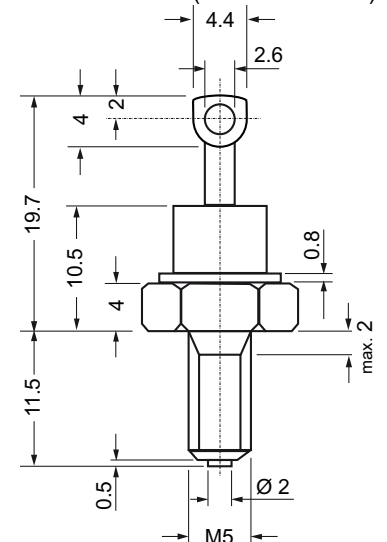

Symbol	Conditions	Characteristic Values		
		typ.	max.	
I_R	$V_R = V_{RRM}$ $T_{VJ} = T_{VJM}$		3	mA
V_F	$I_F = 36 \text{ A}$ $T_{VJ} = 25^\circ\text{C}$		1.4	V
V_{T0}	For power-loss calculations only		0.85	V
r_T	$T_{VJ} = T_{VJM}$		15	mΩ
R_{thJC}	DC current		2	K/W
	180° sine		2.17	K/W
R_{thJH}	DC current		3.0	K/W
d_S	Creepage distance on surface		2.0	mm
d_A	Strike distance through air		2.0	mm
a	Max. allowable acceleration		100	m/s ²

Data according to IEC 60747

IXYS reserves the right to change limits, test conditions and dimensions.

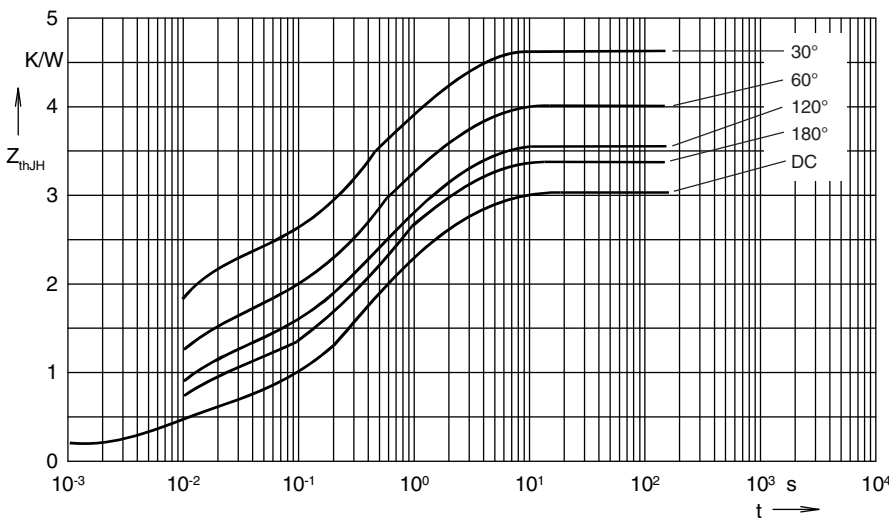
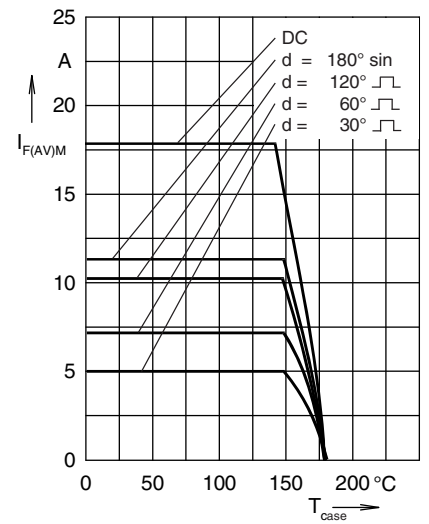
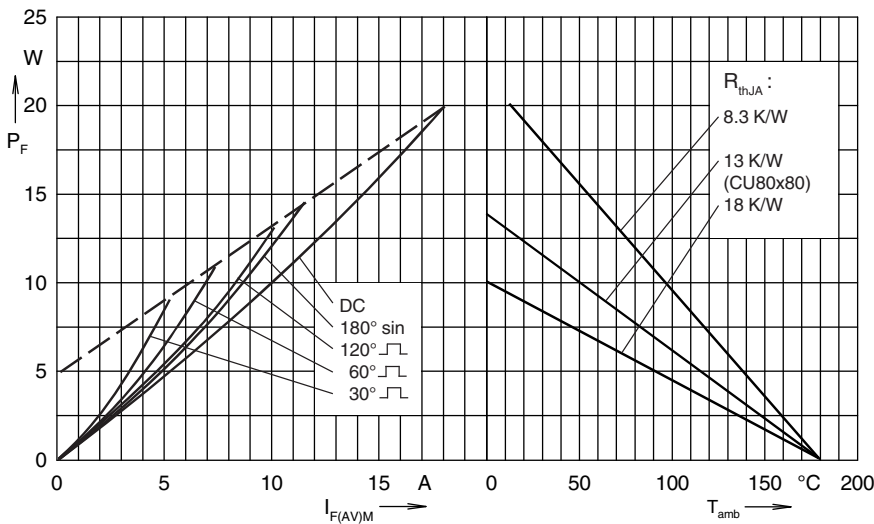
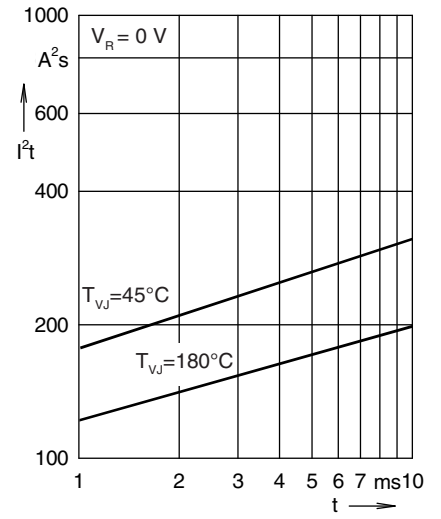
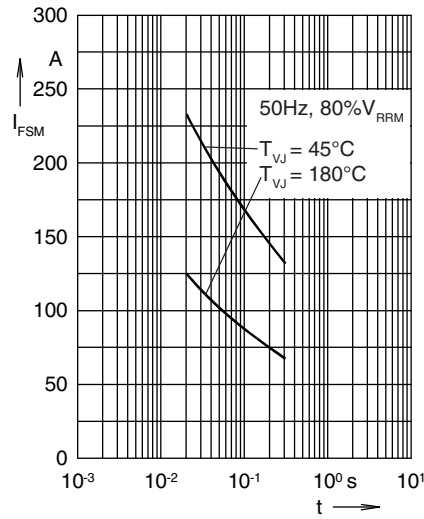
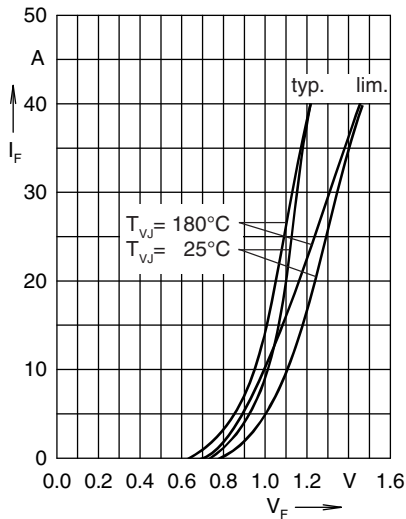

R_{thJH} for various conduction angles d :

d	R_{thJH} (K/W)
DC	3.0
180°	3.35
120°	3.56
60°	4.0
30°	4.64

Constants for Z_{thJH} calculation:

i	R_{thi} (K/W)	t_i (s)
1	0.095	0.00032
2	0.515	0.0102
3	1.39	0.360
4	1.0	2.30